



Instruction Book  
Mode d'emploi  
**PURE F9**







[www.electrolux.com](http://www.electrolux.com)



[www.electrolux.com/productregistration](http://www.electrolux.com/productregistration)



[support.emea.electrolux.com](mailto:support.emea.electrolux.com)





## CONSUMABLES & ACCESSORIES

 [www.electrolux.com/shop](http://www.electrolux.com/shop)

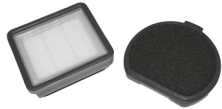
 **PUREF9 Performance Kit**  
Ref: ESPK9  
Part nr: 900169078/4





 **3in1 Nozzle**  
Ref: ZE127  
Part nr: 900922924/7



 **Home & Car kit**  
Ref: KIT18  
Part nr: 900922934/6





 **Citrus Burst**  
Ref: ESMA  
Part nr: 9001677807

 **Evening Rose**  
Ref: ESRO  
Part nr: 9001677765

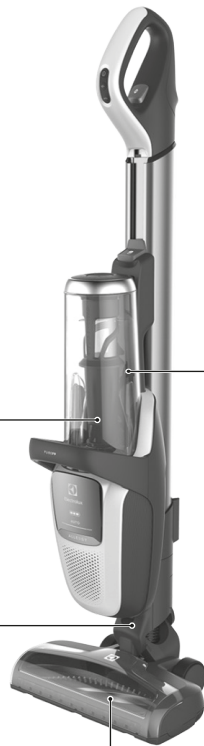

 **S-fresh 18 Value pack**  
Ref: ESVP1  
Part nr: 9001681221



 **Main brush roll all-floors & carpet**  
Ref: ESBA9  
Part nr: 9009229478



 **Long flexible crevice nozzle**  
Ref: ZE121  
Part nr: 9009229619



 **Micro kit**  
Ref: KIT05  
Part nr: 9009229601



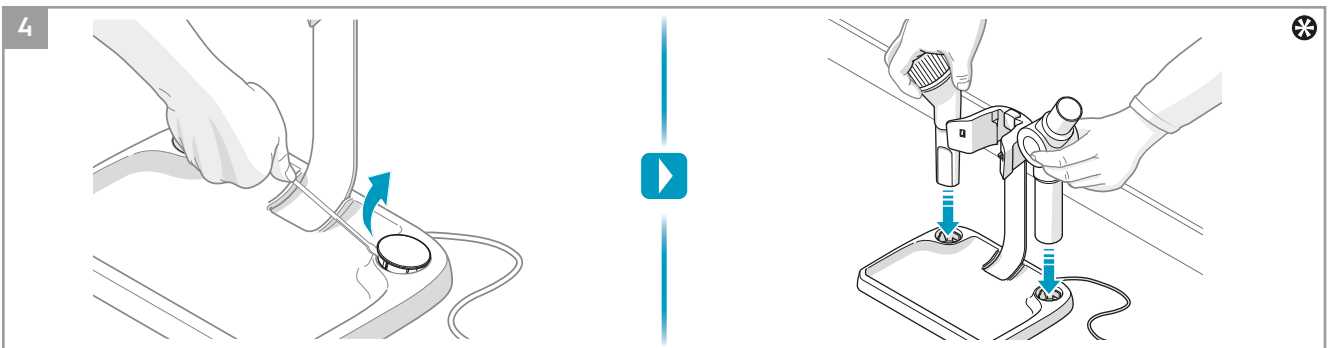
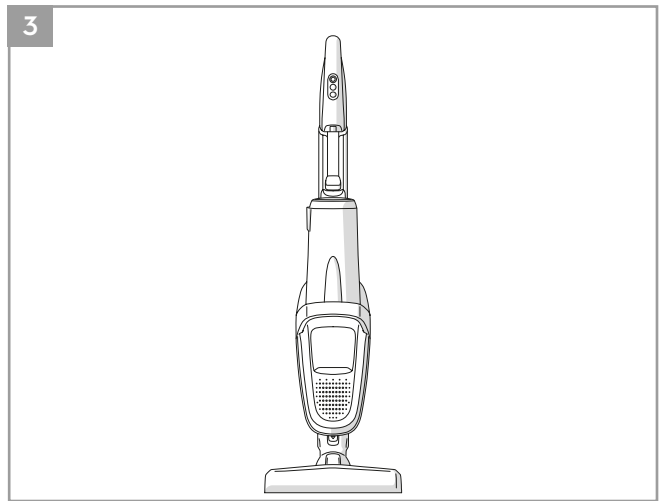
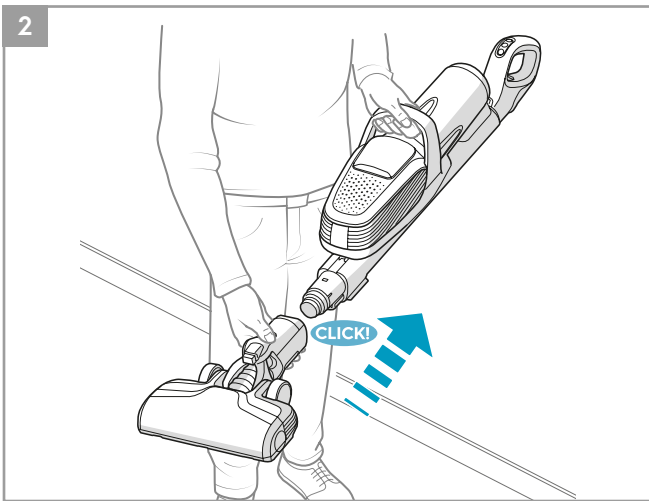
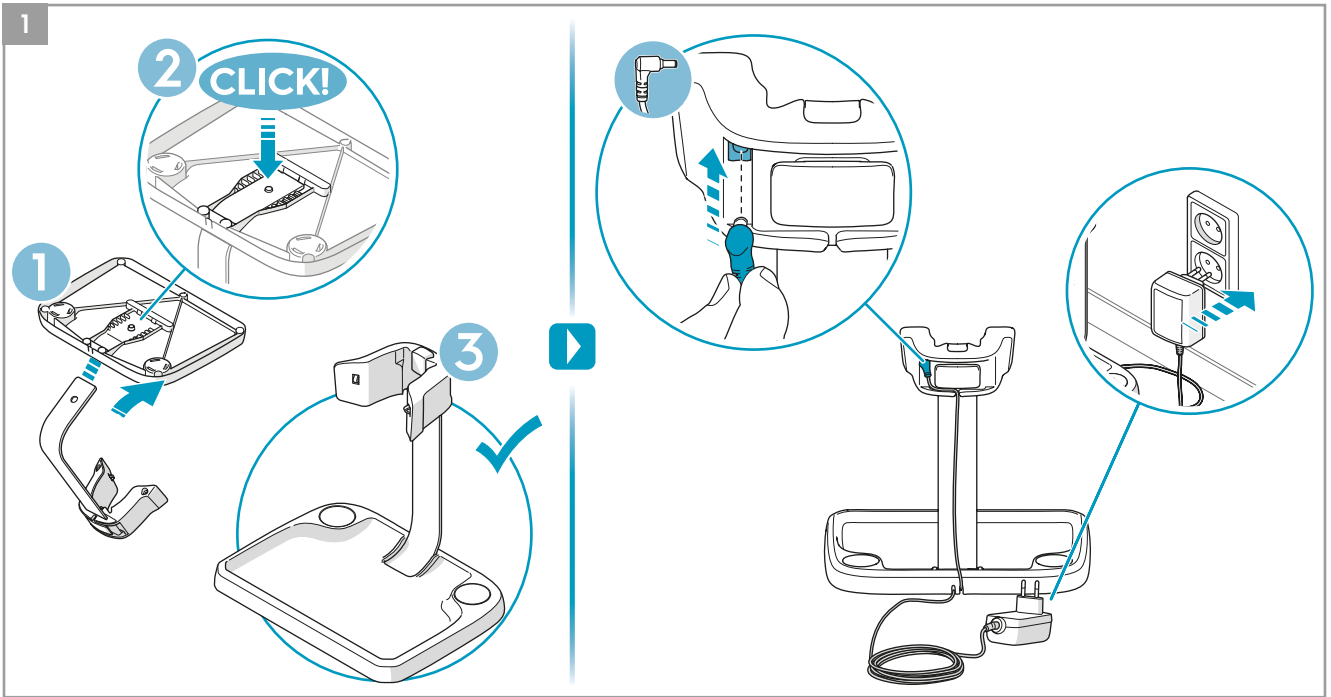
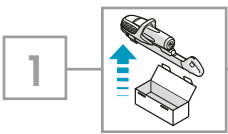

\* PF91-6XXX, PF91-ANIMA, PF91-ALRGY

[www.electrolux.com](http://www.electrolux.com)

2

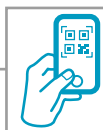
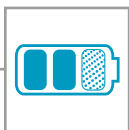

1

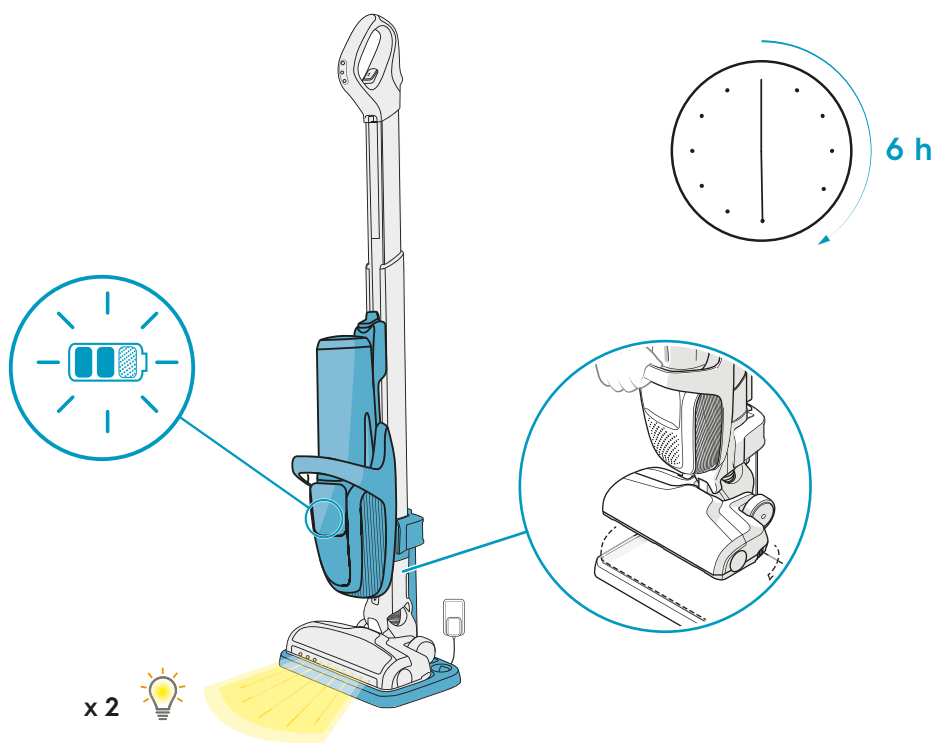

2

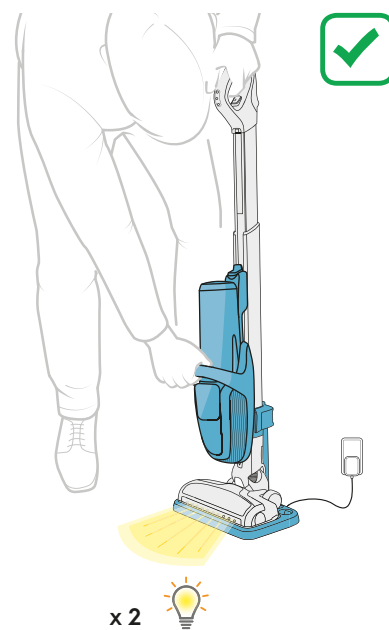
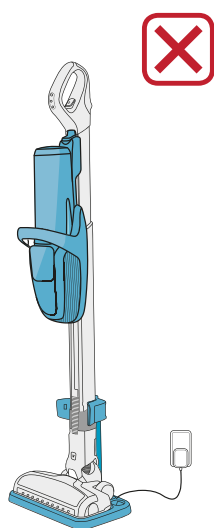

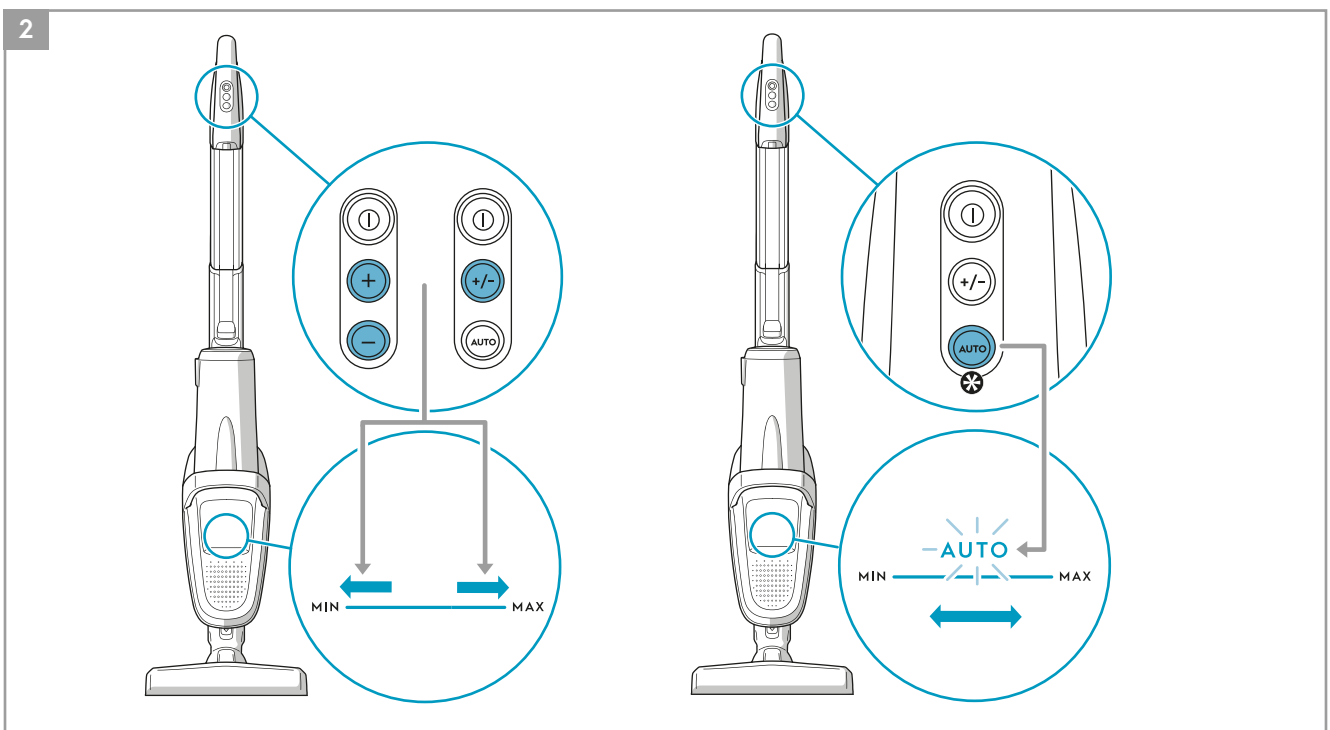
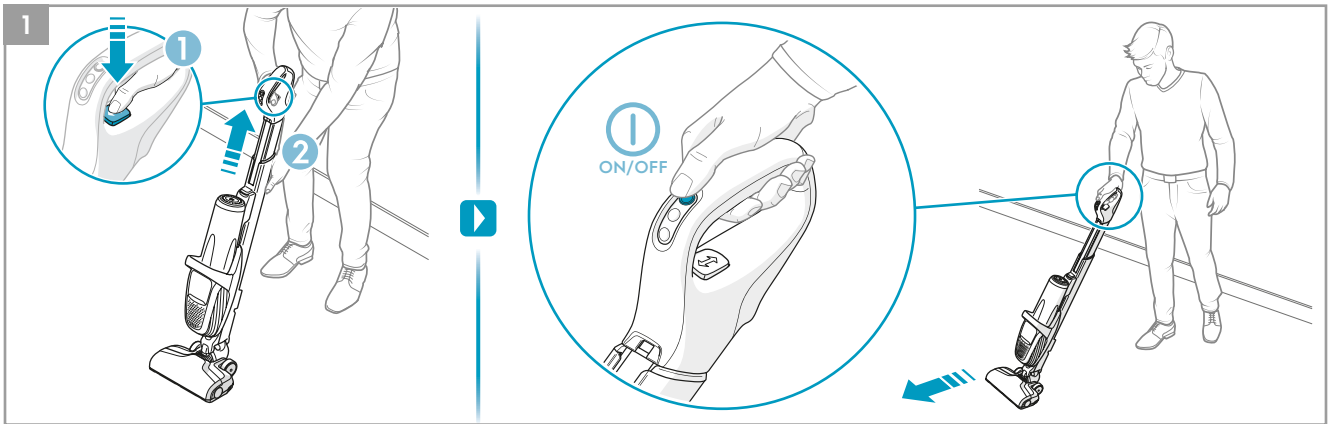
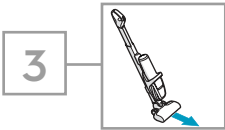

4



1

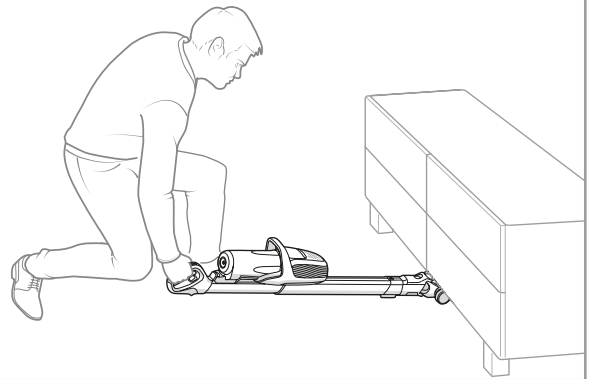
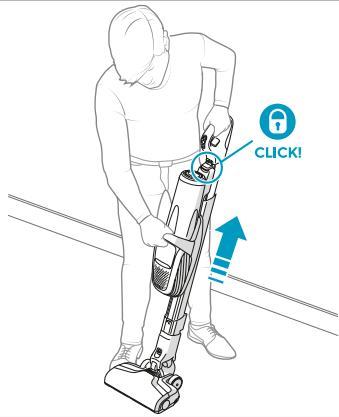

2

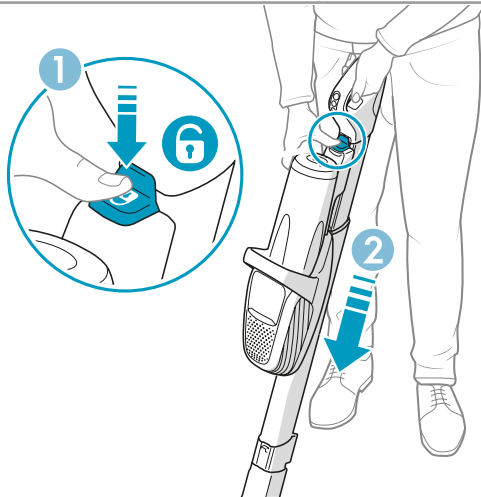

5

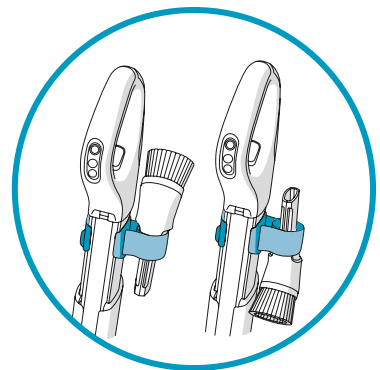
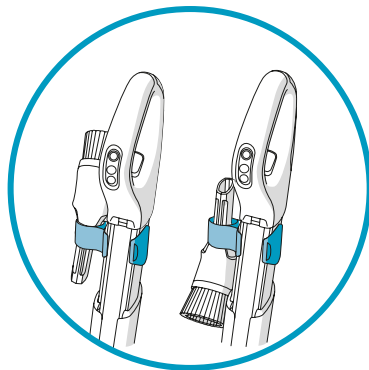
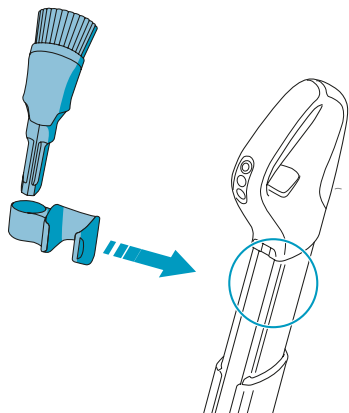
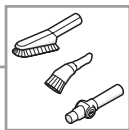
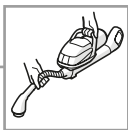

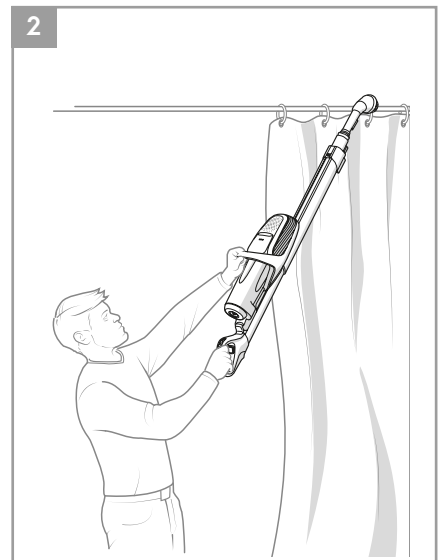
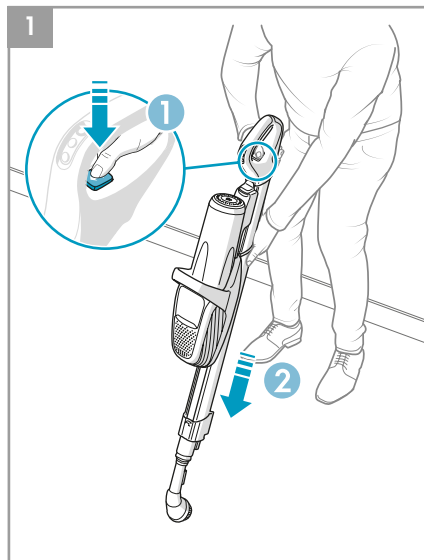
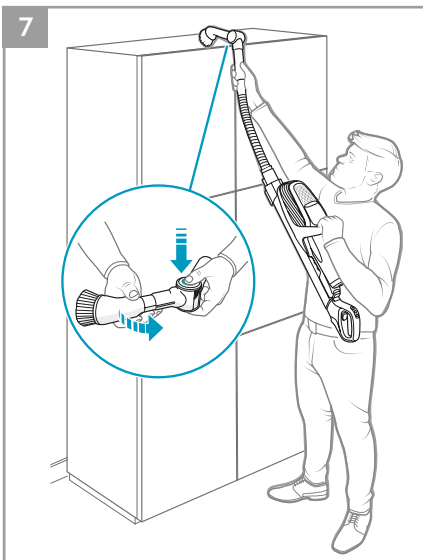
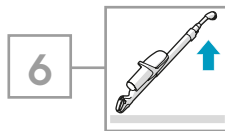
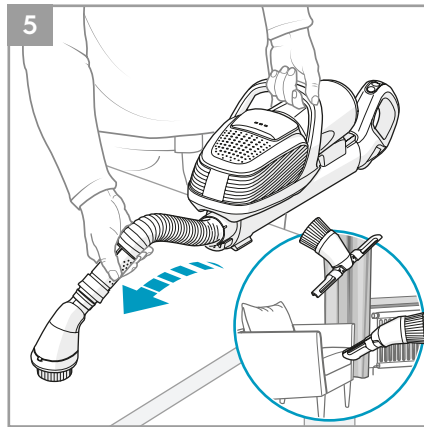
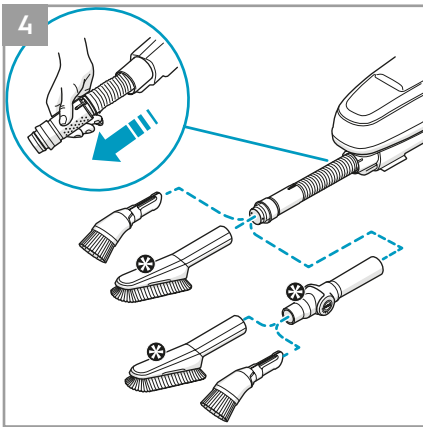
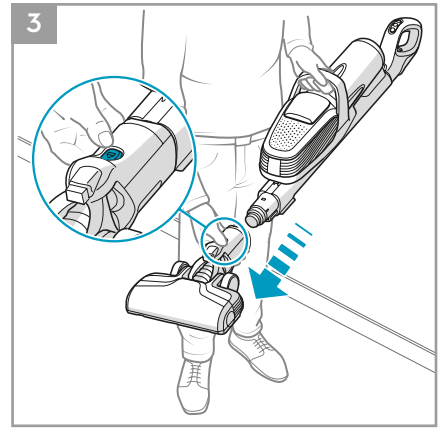
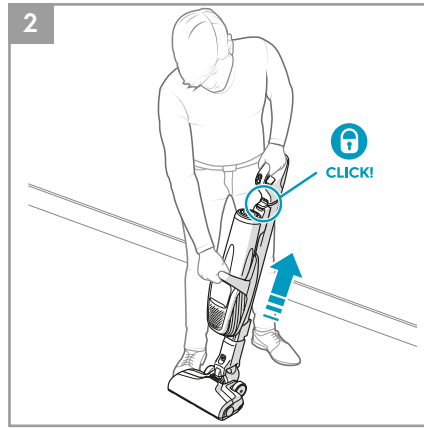
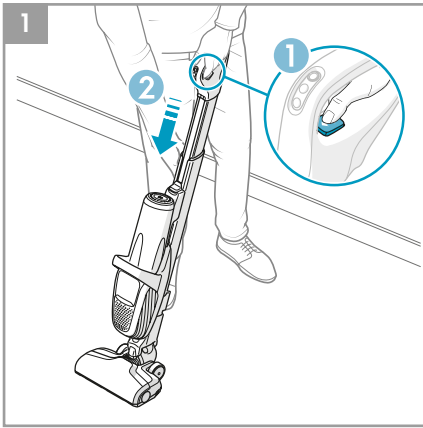

\* Certain models only



